

**COUNCIL MEETING AGENDA REQUEST FORM**

\*\*\*\*\*

COUNCIL MEETING DATE: December 26, 2017

SUBJECT/REASON FOR AGENDA ITEM: \_\_\_\_\_

Temporarily Alcohol Permit Waiver  | Open Container Law Waiver   
Other: \_\_\_\_\_

***Please be specific about the reason to be on the agenda.***

A resolution to authorize the Mayor to enter into contract with Roofing Solutions., for \$43,680.00 to Remove and replace and existing PBR panel roof system for Hanger #15

Requested By: Purchasing

NAME: Jana Thurman

ADDRESS \_\_\_\_\_

PHONE # \_\_\_\_\_ CELL PHONE: \_\_\_\_\_

EMAIL: \_\_\_\_\_ FAX: \_\_\_\_\_

Please note that the Hammond City Council meets the First and Third Tuesday of the Month at 5:30pm, 312 East Charles Street, Hammond, LA 70401, All requests have to be submitted to the City Council Clerk by the Wednesday prior of the meeting no later than 4:30pm, All requests can be submitted electronically to banks\_tm@hammond.org or fax (985) 277-5611. If you have any questions please call (985) 277-5610

**BELOW TO BE FILLED OUT BY COUNCIL CLERK**

\*\*\*\*\*  
\*\*\*\*

DATE RECEIVED: \_\_\_\_\_ TIME RECEIVED: \_\_\_\_\_

Council Clerk: Tonia Banks Agenda Item Number \_\_\_\_\_

Approved: \_\_\_\_\_ (Yes) \_\_\_\_\_ (No)

Remarks: \_\_\_\_\_

\_\_\_\_\_  
Lemar Marshall  
Council President

\_\_\_\_\_  
Tonia Banks  
Council Clerk

\_\_\_\_\_  
Date

**RFP 18-09  
HANGER 15 ROOFING PROJECT  
CITY OF HAMMOND**

**December 1, 2017  
10:00 a. m.**

**Received (3) Three bids:**

	<b>Retro Fit</b>	<b>Replace Roof Alternate</b>
<b>Industrial Roofing &amp; Construction</b>	<b>\$32,670.00</b>	<b>\$46,100.00</b>
<b>Harper Metal Building Services</b>	<b>\$38,731.00</b>	<b>\$49,243.00</b>
<b>Roofing Solutions</b>	<b>\$41,250.00</b>	<b>\$43,680.00</b>

**Bids were due in by 10:00 a. m. Friday, December 1, 2017**

**Present at bid:**

**Jana Thurman, Purchasing Manager  
Nikki Eames, Assistant Purchasing Agent  
Robert Morgan, Director of Streets  
Butch Caballero, Roofing Solutions  
Todd, Roofing Solutions**



**City Of Hammond  
Purchasing Department**

**RFP # 18-09  
For  
Hanger 15 Roofing Project**

**Sealed Proposals Shall Be Received by the Purchasing Department,  
City of Hammond  
310 East Charles Street  
P. O. Box 2788  
Hammond, Louisiana 70404-2788**

**Until**

**10:00 a. m. on December 1, 2017**

**At Which Time All Proposals Will Be Opened and Read Aloud**

**Advertisement in the Official Journal, Daily Star, to be published Three (3) Times  
October 26, November 1 and 8, 2017**

**Jana Thurman - Purchasing Manager- (985)-277-5633**

**Mandatory Pre-Proposal Conference has been scheduled for November 14, 2017 at 9:00 am at  
the location of the Airport Terminal:**

**This is the Proposal of:**

**Date:** 12/01/2017

**Company:** Roofing Solutions, L.L.C.

**Section 3 Business/WBE/SBE/MBE/DBE:** N/A

**Address:** 37302 Commerce Lane

**City:** Prairieville, Louisiana **State:**            **ZIP Code:** 70769

**Person to Contact:** Butch Caballero

**Phone:** 225-744-3912 **Fax:** 225-744-0037

**Email:** estimating@roofingsolutionsla.com

**Your Proposal is important to us.**

However, should you choose NOT to submit a Proposal for this project, the City would still ask you to complete this sheet and indicate "No Proposal". This shall NOT affect your participation in future RFPs, but only serve as a means of verifying you received notification of this RFP.

**Section 3 Business/WBE/SBE/MBE/DBE**

The City encourages Proposals from Section 3 businesses, Woman Business Enterprises, Minority Business Enterprises, Small Business Enterprises, and other potentially Disadvantaged Business Enterprises. If your company is one of these types of businesses, please indicate "Section 3," "WBE," "SBE," "MBE," or "DBE" in the space provided above.

**Nondiscrimination Requirements**

By submitting and signing this Proposal, the Proposer agrees to comply with Title VI and VII of the Civil Rights Act of 1964 as amended; the Vietnam Era Veterans Readjustment Assistance Act of 1974; Section 503 of the Rehabilitation Act of 1973; Section 202 of Executive Order 11246 as amended; and the Americans with Disabilities Act of 1990.

The Proposer also agrees to keep informed of and comply with all federal, State, and local laws, ordinances, and regulations which affect the Proposer's employees or prospective employees.

**BID BOND**  
**FOR**

RFP # 18-09, Hanger 15 Roofing Project

Date: 12/1/2017

KNOW ALL MEN BY THESE PRESENTS:

That Roofing Solutions, LLC. of Prairieville, LA 70769, as Principal, and SureTec Insurance Company, as Surety, are held and firmly bound unto the City of Hammond, Purchasing Department (Obligee), in the full and just sum of five (5%) percent of the total amount of this bid, including all alternates, lawful money of the United States, for payment of which sum, well and truly be made, we bind ourselves, our heirs, executors, administrators, successors and assigns, jointly and severally firmly by these presents.

Surety represents that it is listed on the current U. S. Department of the Treasury Financial Management Service list of approved bonding companies as approved for an amount equal to or greater that the amount for which it obligates itself in this instrument or that it is a Louisiana domiciled insurance company with at least an A - rating in the latest printing of the A. M. Best's Key Rating Guide. If surety qualifies by virtue of its Best's listing, the Bond amount may not exceed ten percent of policyholders' surplus as shown in the latest A. M. Best's Key Rating Guide.

Surety further represents that it is licensed to do business in the State of Louisiana and that this Bond is signed by surety's agent or attorney-in-fact. This Bid Bond is accompanied by appropriate power of attorney.

THE CONDITION OF THIS OBLIGATION IS SUCH that, whereas said Principal is herewith submitting its proposal to the Obligee on a Contract for:

RFP # 18-09, Hanger 15 Roofing Project

NOW, THEREFORE, if the said Contract be awarded to the Principal and the Principal shall, within such time as may be specified, enter into the Contract in writing and give a good and sufficient bond to secure the performance of the terms and conditions of the Contract with surety acceptable to the Obligee, then this obligation shall be void; otherwise this obligation shall become due and payable.

Roofing Solutions, LLC.

PRINCIPAL (BIDDER)

BY:   
AUTHORIZED OFFICER-OWNER-PARTNER

SureTec Insurance Company

SURETY

BY:   
AGENT OR ATTORNEY-IN-FACT (SEAL)  
Mary Catherine Turner, Attorney-in-Fact

BID BOND

FOR

WORK TO BE DONE AT THE PLACE INDICATED HEREIN

TO BE FILLED BY THE CONTRACTOR

THE CONTRACTOR'S OBLIGATION IN THIS BID BOND IS TO GUARANTEE THE CONTRACTOR'S PERFORMANCE AND OBLIGATION UNDER THE CONTRACT AND TO GUARANTEE THE CONTRACTOR'S OBLIGATION TO PAY THE DEBTS AND LIABILITIES INCURRED BY HIM IN CONNECTION WITH THE CONTRACT. THE CONTRACTOR'S OBLIGATION UNDER THIS BID BOND IS SEVERAL AND JOINT WITH THE OBLIGATION OF THE CONTRACTOR UNDER THE CONTRACT. THE CONTRACTOR'S OBLIGATION UNDER THIS BID BOND IS NOT TO BE LIMITED BY ANY OTHER PROVISIONS OF ANY OTHER INSTRUMENT, INCLUDING ANY INSTRUMENTS WHICH THE CONTRACTOR MAY HAVE EXECUTED IN CONNECTION WITH THE CONTRACT. THE CONTRACTOR'S OBLIGATION UNDER THIS BID BOND IS NOT TO BE LIMITED BY ANY OTHER PROVISIONS OF ANY OTHER INSTRUMENT, INCLUDING ANY INSTRUMENTS WHICH THE CONTRACTOR MAY HAVE EXECUTED IN CONNECTION WITH THE CONTRACT. THE CONTRACTOR'S OBLIGATION UNDER THIS BID BOND IS NOT TO BE LIMITED BY ANY OTHER PROVISIONS OF ANY OTHER INSTRUMENT, INCLUDING ANY INSTRUMENTS WHICH THE CONTRACTOR MAY HAVE EXECUTED IN CONNECTION WITH THE CONTRACT.

BY \_\_\_\_\_  
AGENT OR ATTORNEY-IN-FACT OF CONTRACTOR

General Contracting Co.  
3/1/17  
CORPORATE SEAL

Hanger 15 Roofing Project

**Name of Project**

RFP#: 18-09

**Project No.**

STATE OF Ascension

PARISH OF Louisiana

**ATTESTATIONS AFFIDAVIT**

**Before me**, the undersigned notary public, duly commissioned and qualified in and for the parish and state aforesaid, personally came and appeared Affiant, who after being duly sworn, attested as follows:

**LA. R.S. 38:2227 PAST CRIMINAL CONVICTIONS OF BIDDERS**

A. No sole proprietor or individual partner, incorporator, director, manager, officer, organizer, or member who has a minimum of a ten percent (10%) ownership in the bidding entity named below has been convicted of, or has entered a plea of guilty or nolo contendere to any of the following state crimes or equivalent federal crimes:

(a) Public bribery (R.S. 14:118)

(c) Extortion (R.S. 14:66)

(b) Corrupt influencing (R.S. 14:120)

(d) Money laundering (R.S. 14:23)

B. Within the past five years from the project bid date, no sole proprietor or individual partner, incorporator, director, manager, officer, organizer, or member who has a minimum of a ten percent (10%) ownership in the bidding entity named below has been convicted of, or has entered a plea of guilty or nolo contendere to any of the following state crimes or equivalent federal crimes, during the solicitation or execution of a contract or bid awarded pursuant to the provisions of Chapter 10 of Title 38 of the Louisiana Revised Statutes:

(a) Theft (R.S. 14:67)

(f) Bank fraud (R.S. 14:71.1)

(b) Identity Theft (R.S. 14:67.16)

(g) Forgery (R.S. 14:72)

(c) Theft of a business record  
(R.S.14:67.20)

(h) Contractors; misapplication of  
payments (R.S. 14:202)

(d) False accounting (R.S. 14:70)

(i) Malfeasance in office (R.S. 14:134)

(e) Issuing worthless checks  
(R.S. 14:71)

**LA. R.S. 38:2212.10 Verification of Employees**

A. At the time of bidding, Appearer is registered and participates in a status verification system to verify that all new hires in the state of Louisiana are legal citizens of the United States or are legal aliens.

B. If awarded the contract, Appearer shall continue, during the term of the contract, to utilize a status verification system to verify the legal status of all new employees in the state of Louisiana.

C. If awarded the contract, Appearer shall require all subcontractors to submit to it a sworn affidavit verifying compliance with Paragraphs (A) and (B) of this Subsection.

Hanger 15 Roofing Project

**Name of Project**

RFP#: 18-09

**Project No.**

STATE OF LOUISIANA  
PARISH OF Ascension

PROJECT NO. RFP#: 18-09  
LOCATION Hammond, LA

NAME Hanger 15 Roofing Project

### AFFIDAVIT

Before me, the undersigned authority, duly commissioned and qualified within and for the State and Parish aforesaid, personally came and appeared Ileana Romero representing Roofing Solutions, L.L.C. who, being by me first duly sworn deposed and said that he has read this affidavit and does hereby agree under oath to comply with all provisions herein as follows:

#### PART I.

Section 2224 of Part II of Chapter 10 of Title 38 of the Louisiana Revised Statutes, as amended.

- (1) That affiant employed no person, corporation, firm, association, or other organization, either directly or indirectly, to secure the public contract under which he received payment, other than persons regularly employed by the affiant whose services in connection with the construction, alteration or demolition of the public building or project or in securing the public contract were in the regular course of their duties for affiant; and
- (2) That no part of the Contract price received by affiant was paid or will be paid to any person, corporation, firm, association, or other organization for soliciting the Contract, other than the payment of their normal compensation to persons regularly employed by the affiant whose services in connection with the construction, alteration or demolition of the public building or project were in the regular course of their duties for affiant.

#### PART II.

Section 2190 of Part I of Chapter 10 of Title 38 of the Louisiana Revised Statutes, as amended.

That affiant, if an architect or engineer, or representative thereof, does not own a substantial financial interest, either directly or indirectly, in any corporation, firm, partnership, or other organization which supplies materials for the construction of a public work when the architect or engineer has performed architectural or engineering services, either directly or indirectly, in connection with the public work for which the materials are being supplied.

For the purposes of this Section, a "substantial financial interest" shall exclude any interest in stock being traded on the American Stock Exchange or the New York Stock Exchange.

That affiant, if subject to the provisions of this section, does hereby agree to be subject to the penalties involved for the violation of this section.

Ileana Romero  
AFFIANT

SWORN TO AND SUBSCRIBED BEFORE ME THIS 20<sup>th</sup> DAY OF Nov, 2017.

Beverly S. Summers  
NOTARY

**Beverly S. Summers**  
LA Notary ID #128290  
My Commission is for Life



**LA. R.S. 23:1726(B) Certification Regarding Unpaid Workers Compensation Insurance**

- A. R.S. 23:1726 prohibits any entity against whom an assessment under Part X of Chapter 11 of Title 23 of the Louisiana Revised Statutes of 1950 (Alternative Collection Procedures & Assessments) is in effect, and whose right to appeal that assessment is exhausted, from submitting a bid or proposal for or obtaining any contract pursuant to Chapter 10 of Title 38 of the Louisiana Revised Statutes of 1950 and Chapters 16 and 17 of Title 39 of the Louisiana Revised Statutes of 1950.
- B. By signing this bid /proposal, Affiant certifies that no such assessment is in effect against the bidding / proposing entity.

Roofing Solutions, L.L.C.  
NAME OF BIDDER

Ileana Romero  
NAME OF AUTHORIZED SIGNATORY OF BIDDER

12/01/2017  
DATE

Authorized Representative  
TITLE OF AUTHORIZED SIGNATORY OF BIDDER

*Ileana Romero*  
SIGNATURE OF AUTHORIZED  
SIGNATORY OF BIDDER/AFFIANT

Sworn to and subscribed before me by Affiant on the 20<sup>th</sup> day of Nov, 20 17

*Beverly S. Summers*  
Notary Public

Beverly S. Summers  
LA Notary ID #128290  
My Commission is for Life

## Specifications

THIS PROJECT SCOPE CONSISTS OF ROOF RENOVATIONS TO HANGER 15 LOCATED AT 600 JUDGE LEON FORD DRIVE, HAMMOND LA. 70401

### **PRE-PROPOSAL CONFERENCE**

**A Mandatory Proposer's conference** has been scheduled for **November 14, 2017 at 9:00 am** at the location of the Airport Terminal:

600 Judge Leon Ford Dr., Hammond, LA 70401

Attendance is mandatory, interested proposers are highly encouraged to attend. In order to make the meeting more effective for all participants, attendees should read this document thoroughly prior to the meeting.

Substantial clarifications or changes required as a result of the meeting will be issued in the form of a written addendum to the RFP.

Specifications/Drawings electronic version can be emailed; for a hard copy, please call Jana Thurman 985-277-5633.

### **SCOPE OF WORK:**

Retrofit and existing PBR panel roof system at Hanger #15  
Building size 81' wide x 84' long x 21' tall with a 1:12 roof slope

### **SPECIFICATIONS:**

1. Provide and install Retro-R, 29 gauge roof system by MBCI metal roof and wall systems or equivalent system. All criteria of alternate suppliers must be comparable with MBCI Retro-R specifications.
2. Install retro system as per manufacturer's instructions and use only fasteners specifically specified for this application. (1/4"-14x7/8" Long-Life Lap-Tek with washer and 1/4" x 1 1/4" long life self-drillers with washer)
3. Use Retro-R Die formed ridge cap
4. Tape sealer where applicable - 1" x 3/32"
5. Remove existing roof vents and replace with new.
6. Remove gutters, downspouts, rake, and eave trim and replace with new material to match existing as closely as possible in a Signature 200 series standard color paint choice. All trim to be from 26 gauge coil stock and should be the same size and profile as those removed.
7. See attached details for reference. Contractor to provide manufacturer's installation guide and have on site during the installation process.
8. Contractor to provide construction dumpster and temporary sanitary facilities.

**ALTERNATE:**

**SCOPE OF WORK:**

Remove and replace and existing PBR panel roof system at Hanger #15

**SPECIFICATIONS:**

1. Remove existing roof system including insulation and haul off site.
2. New roof panels to be 26 gauge, Galvalume PBR Panel, yield 80,000 psi. (80#s per square)
3. New insulation to be three inch VRR plus PSK reinforced vinyl back complete with double three inch tabs and secured with double side stick tape.
4. Do not remove more than one bay of the roof at a time or no more than can be replaced and water tight before the end of the work day.
  
5. Remove roof vents, remove old sealant, and reinstall.
6. Remove existing skylight panels and replace with PBR roof panels.
7. Provide long life fasteners 1/4"-14x7/8" and 1/4" x 1 1/4" self-drillers with washer
8. Use 1" x 3/32" tape seal at all laps.
9. Provide new die-formed peak sheets.
10. Remove gutters, downspouts, rake, and eave trim and replace with new material to match existing as closely as possible in a Signature 200 series standard color paint choice. All trim to be from 26 gauge coil stock and should be the same size and profile as those removed.
11. Contractor to provide construction dumpster and temporary sanitary facilities.

# Retro-R®

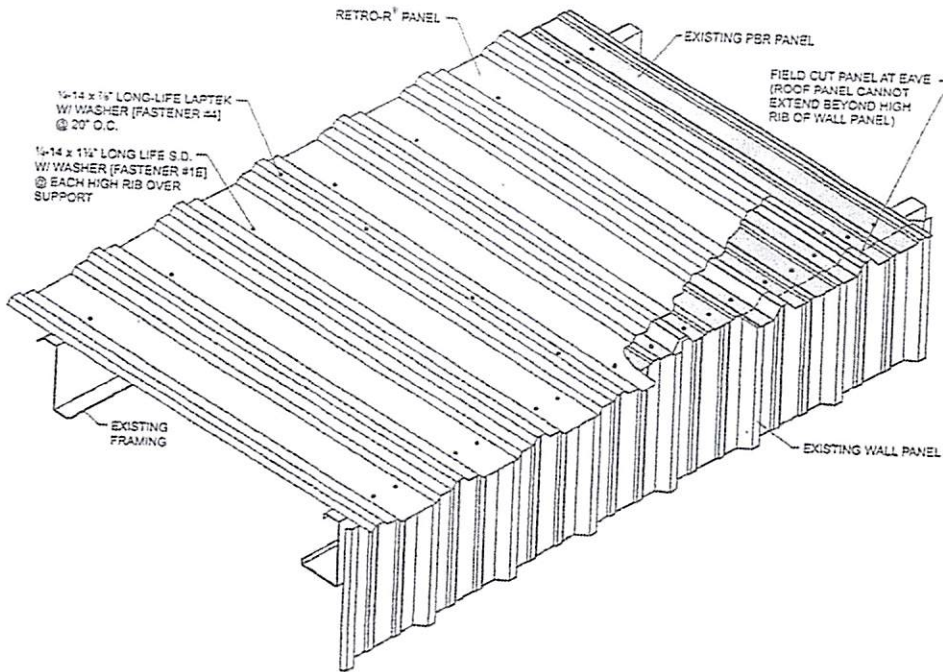

## Retro-R®

### Retro-R® Endlap

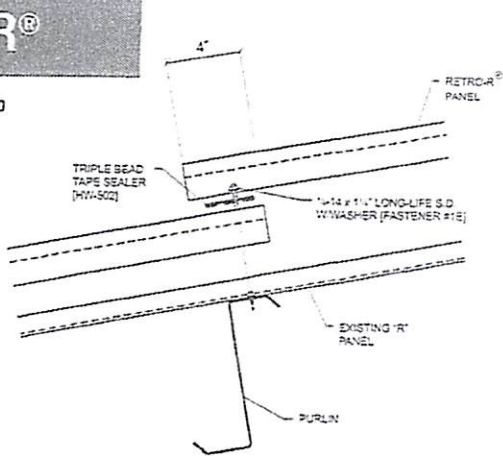

### Retro-R® Eave

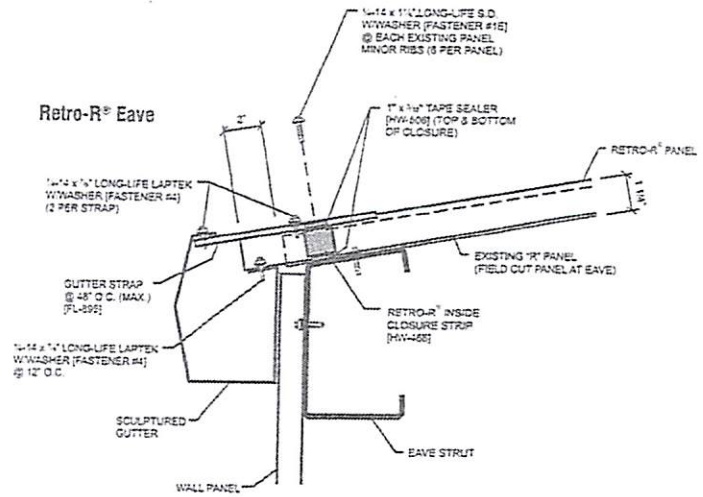

### Retro-R® Rake

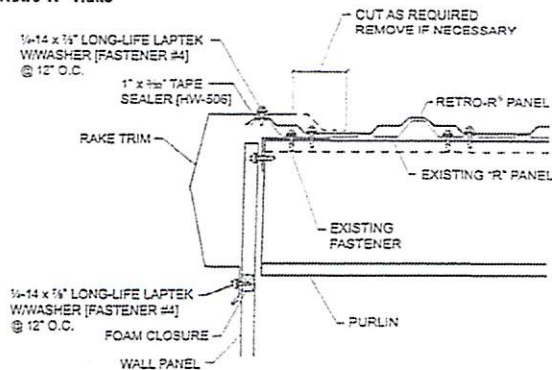

### Retro-R® Ridge

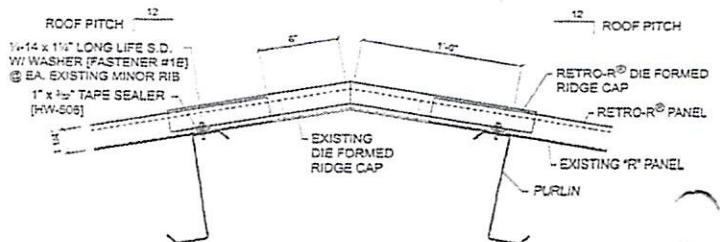

## Instructions to proposers

**PROPOSERS ARE URGED TO PROMPTLY REVIEW THE REQUIREMENTS OF ALL SPECIFICATIONS AND SUBMIT QUESTIONS FOR RESOLUTION AS EARLY AS POSSIBLE DURING THE SUBMITTAL PERIOD. QUESTIONS OR CONCERNS MUST BE SUBMITTED TO THE PURCHASING MANAGER DURING THE PROPOSAL PERIOD AND SHALL BECOME PART OF YOUR PROPOSAL PACKAGE. OTHERWISE, THIS WILL BE CONSTRUED AS ACCEPTANCE BY THE PROPOSERS THAT THE INTENT OF THE SPECIFICATIONS IS CLEAR AND THAT COMPETITIVE PROPOSALS MAY BE OBTAINED AS SPECIFIED HEREIN. PROTESTS WITH REGARD TO THE SPECIFICATION DOCUMENTS SHALL NOT BE CONSIDERED AFTER PROPOSALS ARE OPENED.**

RFP Packages are mailed only as a courtesy. The City of Hammond does not assume responsibility for proposers to receive RFP packages. Proposers should rely on advertisements in the local newspaper, City Website, and personally pick up RFP packages with specifications. Full information may be obtained, or questions answered, by contacting the Purchasing Department, Hammond City Hall Complex, 310 East Charles Street or by calling Robert Morgan (985) 969-1636.

**These specifications are written in a manner to invite open competition. Any manufacturer's names, trade names, brand names, or catalog numbers used in the specifications are for the purpose of describing and establishing general quality levels. Such references are not intended to be restrictive unless the RFP states that only the brand name will be considered for reasons of compatibility, etc.**

**The RFP number, Proposers name, address, Louisiana Contractor License number and RFP opening date shall be clearly printed or typed on the outside of the Proposal envelope, if mailed. Only one (1) proposal shall be accepted from each proposer. Alternates shall not be accepted unless specifically requested in the RFP specifications. Proposals can be delivered or mailed.**

The method of delivery of proposals is the responsibility of the proposer. All proposals shall be received by the Purchasing Department, Hammond City Hall Complex, 310 East Charles Street Hammond, Louisiana on or before the specified RFP opening date and time. Normally, bid bonds will not be required on bids for materials, supplies, annual contracts or small labor contracts. If a bid bond is required, it will be specifically requested on the RFP form and included in the specifications.

Proposals shall be accepted only on the RFP forms furnished by the City of Hammond Purchasing Department. The City of Hammond shall only accept proposals from those proposers in whose name the RFP forms and or specifications were issued. Altered or incomplete proposals forms, or use of substitute forms or documents, shall render the proposal non-responsive and subject to rejection. The entire RFP package, including the specifications and copies of any addenda issued shall be submitted to the Purchasing Department as THE RFP.

All proposals must be typed or written in **BLUE/BLACK INK**. Any erasures, strikeover and/or changes to prices shall be initialed by the proposer. Failure to initial shall be cause for rejection of the proposal as non-responsive.

All proposals shall be signed. Failure to do so shall cause the proposal to be rejected as non-responsive.

Where one (1) or more vendor's exact products or typical workmanship is designated as the level of quality desired or equivalent, the Purchasing Agent/Airport Director, after study and review, reserves the right to determine the acceptability of any equivalent offered. The decision, after study and review, shall be final and binding.

If proposing "equivalent" products, specifications, illustrative literature and any deviations shall be submitted with proposal. Representative samples shall be submitted upon request, if appropriate.

**Liability:**

The Contractor at all times during the term of the contract shall maintain and pay for property damage and public liability insurance with limits of at least (\$1,000,000.00) one million dollars inclusive of bodily injury and property damage for any one occurrence.

Prior to commencing work under this contract the Contractor must file with the City a "certificate of insurance" meeting aforementioned requirements with the City of Hammond named insured by added endorsement. All premiums and expense incurred with this insurance shall be paid for by the Contractor.

The Contractor shall assume the defense of and indemnify and save harmless the City and its Officers and Agents from all claims relating to work.

The Contractor shall be responsible for any and all damages or claims for damages or injuries or accidents done or caused by him or his employees, or resulting from the execution of the work, or any operations, or caused by reason of existence or location or condition of facilities or of any materials, supplies, or machinery used thereon or therein, or neglect or omission on his part, or all of the several acts or things required to be done by them, under and by these conditions, and covenants, and agrees to hold the City harmless and indemnified for all such damages and claims for damages.

The Contractor shall indemnify and save harmless the City from and against all losses and all claims, demands, payments, suits, actions, recoveries, all attorney fees, and judgments of every nature and description made, brought or recovered against the City by reason of any act or omission of the Contractor, his agents or employees, in the execution of his work.

**Worker's Compensation:**

The Contractor shall, at all times, pay or cause to be paid, any assessment or compensation required to be paid pursuant to the Worker's Compensation Act.

The Contractor shall, at the time of entering into a Contract with the City, provide satisfactory proof that all assessments or compensation payable to the Worker's Compensation Board have been paid and the City may, at any time during the performance or upon the completion of such Contract require a further declaration such Contract require a further declaration that such assessments or compensations have been paid.

**Performance Bond:**

The Contractor shall furnish and pay for a Performance Bond written by a company licensed to do business in Louisiana, and shall be countersigned by a person who is contracted with the surety company or bond issuer as an agent of the company or issuer, and who is licensed as an insurance agent in this state, and who is residing in this state, in an amount equal to the 100% contract amount.

**Sealed RFP Form for Public RFP 18-09**

**As a qualified proposer for the project, I have carefully examined all of the RFP Documents and have examined the conditions and specifications of the work to be done, and I hereby propose to furnish all labor, materials, equipment, tools, etc., as called for by the RFP specifications.**

**I hereby acknowledge that I have received the following Addenda and they are reflected as part of this proposal,**

List by date and Addendum number N/A

I certify that I am duly licensed in Louisiana to perform the work. Louisiana License # 44196

Work to be complete within 30 days after receipt of order.

**Proposal Amount**

Proposer agrees to Furnish All Material, Equipment, Supplies and Services in complete accordance with all RFP 18-09 Specifications for the sum indicated:

(Amounts shall be shown in words and digits. In case of discrepancy, words shall govern.)

Retro Fit Total Price Forty One Thousand Two Hundred Fifty <sup>9/100</sup> DOLLARS  
(\$ 41,250.00 )

Replace Roof Alternate Price Forty Three Thousand Six Hundred <sup>Eighty 9/100</sup> DOLLARS  
(\$ 43,680.00 )

*[Signature]*  
Signature of Proposer

Roofing Solutions, L.L.C.  
Company Name

The above signature on this Sealed Proposal certifies that proposer has carefully examined the instructions to proposers, terms and specifications applicable to and made a part of this Seal Proposal Package. Proposer further certifies that the prices shown are in full compliance with the conditions, terms and specifications of this Sealed RFP.

---

# SureTec Insurance Company

## LIMITED POWER OF ATTORNEY

Know All Men by These Presents, That SURETEC INSURANCE COMPANY (the "Company"), a corporation duly organized and existing under the laws of the State of Texas, and having its principal office in Houston, Harris County, Texas, does by these presents make, constitute and appoint

Mary Catherine Turner, Meghann Turner, Garrett Turner

its true and lawful Attorney-in-fact, with full power and authority hereby conferred in its name, place and stead, to execute, acknowledge and deliver any and all bonds, recognizances, undertakings or other instruments or contracts of suretyship to include waivers to the conditions of contracts and consents of surety for, providing the bond penalty does not exceed

Five Million and 00/100 Dollars (\$5,000,000.00)

and to bind the Company thereby as fully and to the same extent as if such bond were signed by the President, sealed with the corporate seal of the Company and duly attested by its Secretary, hereby ratifying and confirming all that the said Attorney-in-Fact may do in the premises. Said appointment shall continue in force until 12/31/2019 and is made under and by authority of the following resolutions of the Board of Directors of the SureTec Insurance Company:

*Be it Resolved*, that the President, any Vice-President, any Assistant Vice-President, any Secretary or any Assistant Secretary shall be and is hereby vested with full power and authority to appoint any one or more suitable persons as Attorney(s)-in-Fact to represent and act for and on behalf of the Company subject to the following provisions:

*Attorney-in-Fact* may be given full power and authority for and in the name of and of behalf of the Company, to execute, acknowledge and deliver, any and all bonds, recognizances, contracts, agreements or indemnity and other conditional or obligatory undertakings and any and all notices and documents canceling or terminating the Company's liability thereunder, and any such instruments so executed by any such Attorney-in-Fact shall be binding upon the Company as if signed by the President and sealed and effected by the Corporate Secretary.

*Be it Resolved*, that the signature of any authorized officer and seal of the Company heretofore or hereafter affixed to any power of attorney or any certificate relating thereto by facsimile, and any power of attorney or certificate bearing facsimile signature or facsimile seal shall be valid and binding upon the Company with respect to any bond or undertaking to which it is attached. (Adopted at a meeting held on 20<sup>th</sup> of April, 1999.)

In Witness Whereof, SURETEC INSURANCE COMPANY has caused these presents to be signed by its President, and its corporate seal to be hereto affixed this 28th day of March, A.D. 2017.

SURETEC INSURANCE COMPANY

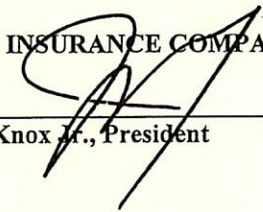
By:   
John Knox Jr., President



State of Texas                      ss:  
County of Harris

On this 28th day of March, A.D. 2017 before me personally came John Knox Jr., to me known, who, being by me duly sworn, did depose and say, that he resides in Houston, Texas, that he is President of SURETEC INSURANCE COMPANY, the company described in and which executed the above instrument; that he knows the seal of said Company; that the seal affixed to said instrument is such corporate seal; that it was so affixed by order of the Board of Directors of said Company; and that he signed his name thereto by like order.

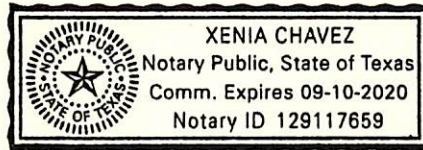

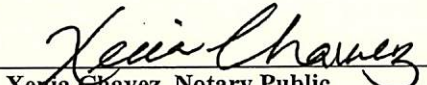
  
Xenia Chavez, Notary Public  
My commission expires September 10, 2020

I, M. Brent Beaty, Assistant Secretary of SURETEC INSURANCE COMPANY, do hereby certify that the above and foregoing is a true and correct copy of a Power of Attorney, executed by said Company, which is still in full force and effect; and furthermore, the resolutions of the Board of Directors, set out in the Power of Attorney are in full force and effect.

Given under my hand and the seal of said Company at Houston, Texas this 1<sup>st</sup> day of Dec, 2017, A.D.

  
M. Brent Beaty, Assistant Secretary

Any instrument issued in excess of the penalty stated above is totally void and without any validity.  
For verification of the authority of this power you may call (713) 812-0800 any business day between 8:00 am and 5:00 pm CST.





# CORPORATE RESOLUTION

BE IT RESOLVED by the Board of Directors of Roofing Solutions, L.L.C. in a meeting duly assembled, that Ileana Romero (Name), Authorized Representative (Title), of the Corporation, be, and she is hereby authorized, empowered and directed for and on behalf of the Corporation to negotiate for and sign any and all bid proposals and/or contracts which this Corporation might enter into for the furnishing of services for the Corporation under such terms, conditions and stipulates, and for such consideration as he might deem to be in the best interest of the Corporation.

\*\*\*\*\*

I, Lautaro de La Cruz (Name), Secretary of Roofing Solutions, L.L.C. do hereby certify that the above and foregoing is a true and correct copy of a Resolution unanimously adopted at a meeting of the Board of Directors of said Corporation held on the day 03 of January, 2017, at which meeting all members of the Board of Directors were present and voted thereon and that said Resolution has been spread upon the minute books of the Corporation, and same is now in full force and effect.

WITNESS MY SIGNATURE this 1<sup>st</sup> day of December 2017, at

Roofing Solutions, L.L.C.

  
\_\_\_\_\_  
Managing Member

  
**State of Louisiana**  
**State Licensing Board for Contractors**

State Licensing Board for Contractors

This is to Certify that:

ROOFING SOLUTIONS, L.L.C.  
 37302 Commerce Ln.  
 Prairieville, LA 70769

is duly licensed and entitled to practice the following classifications

BUILDING CONSTRUCTION; HEAVY CONSTRUCTION; MECHANICAL WORK (STATEWIDE); SPECIALTY:  
 ROOFING AND SHEET METAL, SIDING; SPECIALTY: WATERPROOFING, COATING, SEALING,  
 CONCRETE/MASONRY REPAIR



License No: 44196  
 Expiration Date: October 25, 2020

This License Is Not Transferable

\_\_\_\_\_  
 Director

*W. G. Moore*

Witness our hand and seal of the Board dated, \_\_\_\_\_  
 Baton Rouge, LA \_\_\_\_\_  
 26th day of October 2017

\_\_\_\_\_  
 Chairman

*Lee M. Scott*

\_\_\_\_\_  
 Treasurer

*Andy Wynn*